

PLAN VIEW
(LOUVRES INSIDE REVEAL)

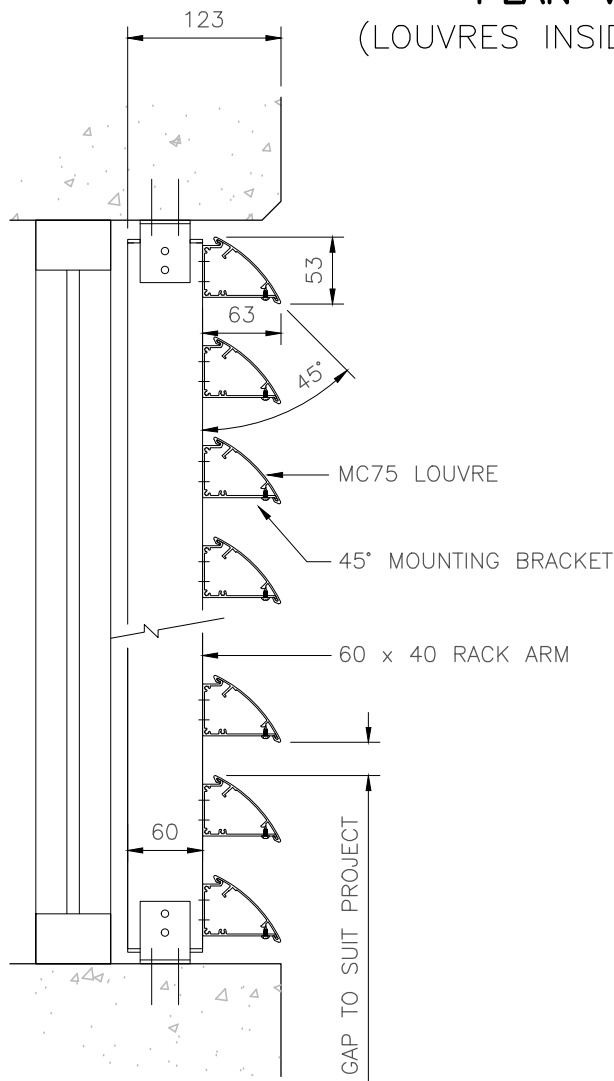

SIDE VIEW

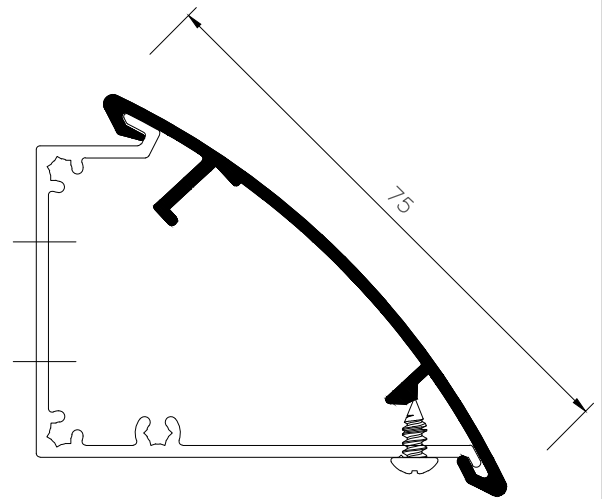

MC75 LOUVRE
(WITH MOUNTING BRACKET)

FIXING BRACKETS AND FIXINGS VARY ACCORDING TO LOCATION AND WIND LOADS

**MC75F MAXIM CONTINUOUS FIXED LOUVRES
AT 45° TO RACK ARM
REVEAL FIXED**

www.maximlouvres.com.au

maxim
louvres

DWG No.: MC75 FIXED 45° RF
DWG DATE: 02-April-2020